

SERIES
KTZ
KTD

SUBMERSIBLE
DEWATERING PUMPS



We Are Original



Submersible Heavy-duty Dewatering Pumps

The KTZ-series is Tsurumi's flagship line of submersible pumps. Made with a cast iron body and high chromium cast iron impeller, the pumps can withstand the most demanding conditions found in construction, aggregate and mining applications. Versatility is increased as each model has the capability of being easily converted between high head and high volume performance with a simple change of impeller, suction cover and hose coupling.

Dual silicon carbide mechanical seals are isolated in the oil chamber to protect the seal faces against abrasion and corrosion. In addition, the seals are enclosed in Tsurumi's original Oil Lifter to ensure reliable lubrication and cooling. This design exceeds the standard configuration of competitors and offers a longer mechanical seal life for a more reliable pump.

Pumps with a 7.5 to 22kW motor incorporate seal pressure relief ports, therefore mechanical seals are exposed only to the pressure developed by the sump submergence level. This virtually eliminates the premature wear and failure of mechanical seals in higher pressure applications.

The KTZE-series is an automatic pump without cumbersome floats. An innovative electrode type relay unit built into the pump automatically starts and stops the pump to eliminate dry-running. This mechanism greatly reduces power consumption and extends operating life.

The KTD-series is a submersible heavy-duty slurry pump utilizing the KTZ-series as the base. It is designed to have more motor shaft power allowance than the KTZ to handle muddy water with higher specific gravities. An agitator suspends solids to assist in pumping sediments in combination with a dedicated strainer. This pump is suitable for transferring or draining bentonite slurry.

Available as optional specifications are an original "seawater-resistant pump" developed over many years by Tsurumi to enable seawater intake/drainage for long periods of time.

Registration of Design

*Tsurumi has registered the design of the KTZ-series in major countries.
Design rights are granted under the laws of each country.*

KTZ/KTD

Submersible Heavy-duty Dewatering Pumps

Major Applications

Extreme circumstances reveal true value.

With 100 years of history, the Tsurumi Pump Brand continues to receive worldwide support with its superior quality, exceptional durability and solid reliability.

CONSTRUCTION



MINING



KTZ: Tsurumi's flagship line of heavy-duty drainage pumps

KTZE: Automatic drainage pumps with an innovative electrode type relay unit

KTD: Slurry pumps that deliver powerful agitation for discharging slurries laden with silt, earth, sand or other particulate

Selection Table

Motor Output		1.5 kW	2.2 kW	3.7 kW	5.5 kW	7.5 kW	11 kW	15 kW	22 kW
KTZ	2" 50mm								
	3" 80mm								
	4" 100mm								
	6" 150mm								
KTZE -Automatic-	2" 50mm								
	3" 80mm								
	4" 100mm								
KTD -Slurry-	2" 50mm								
	3" 80mm								

Model Number Designation

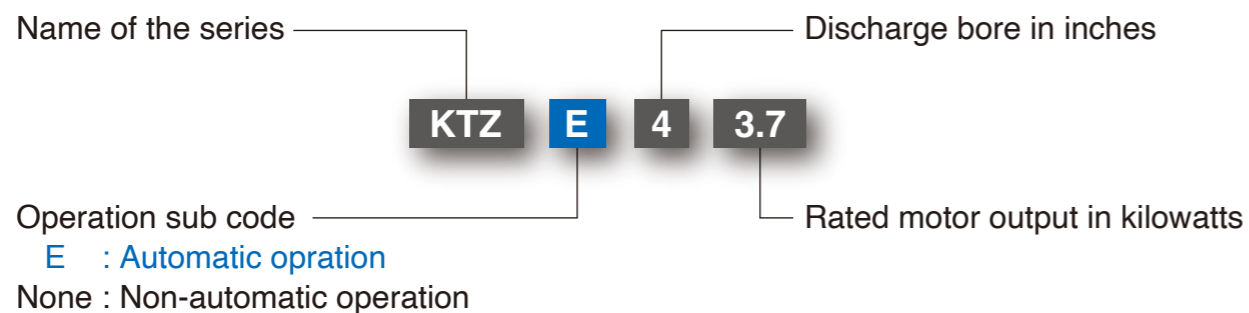

Options

- Seawater-resistant version; Galvanic anode & special impeller
- High temperature liquids version; Max. 80°C
- High voltage version; Max. 1000V

Seawater-Resistant Version

Tsurumi's pumps can be combined with a seawater-resistant kit (optional) that adds a "galvanic anode" and "seawater-resistant special cast iron impeller," and enables about two years of service. (The service period depends on operating conditions.) For details, refer to the Seawater-Resistant Pumps catalog [IB115].



High Temperature Liquids Version

Tsurumi's pumps are applicable to high temperature liquids of up to 80°C. Pumps of the standard specification can discharge liquids of up to 40°C. However, there are many fields that need to discharge higher temperature liquids, e.g., discharging industrial water from a power plant or ironworks, or discharging hot spring water from a mine in a volcanic zone. For details, refer to the Submersible Pumps for High Temperature Liquids catalog [IB117].

High Voltage Version

Tsurumi's pumps can be manufactured to between 380 – 1000V ratings that are often required for mining applications. The pumps meet mining safety standards as they come with screened cables and motors with built-in diodes for ground-fault checks.



Top Discharge, Side Flow Design

This design assures efficient motor cooling even if the pump runs with its motor exposed to air, and also allows the overall diameter of the pump to be reduced for installation in confined spaces.

Model
KTZE43.7

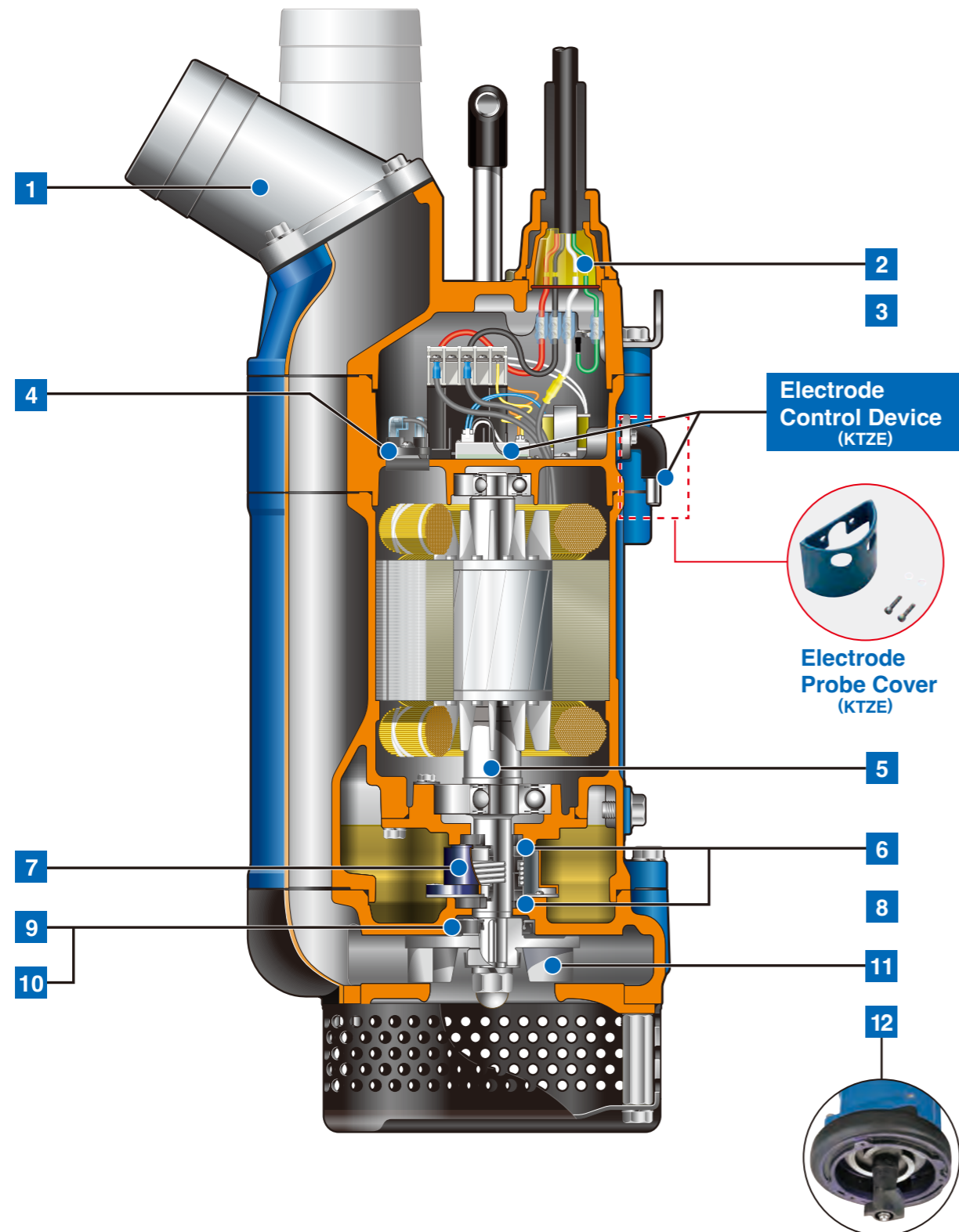

Electrode Control Device (KTZE)

Consisting of an electric probe and relay unit, this enables automatic operation, reduces power consumption and extends operating life.

1 Multi-directional Hose Coupling (KTZ & KTZE)

Can be configured for inclined or vertical discharge, allowing for smoother installation.

2 Anti-wicking Cable Entry

Prevents water incursion due to capillary action should the cable sheath be damaged or the end of cable submerged. Also prevents moist air from infiltrating the motor housing and condensation from forming inside the housing due to temperature differences between the housing and outside air.

3 Cable Clip

Prevents unexpected water incursion that can occur if the cable is damaged, by protecting the cable against the tugging and rough handling found at construction sites.

4 Circle Thermal Protector

Directly cuts the motor circuit if excessive heat builds up or overcurrent occurs in the motor.

5 Shaft

Quenching treatment is applied to parts that contact particles in pumped fluids and whose mechanical seal may wear out, to enhance surface hardness and extend shaft service life.

6 Dual Inside Mechanical Seals with Silicon Carbide Faces

Isolated in the oil chamber where a clean, non-corrosive and abrasion-free lubricating environment is maintained. Compared with the water-cooled outside mechanical seal, it reduces the risk of failure caused by dry-heating and adhering matter. The silicon carbide provides 5 times higher corrosion, wear and heat resistance than the tungsten carbide. Rubber parts of the upper and lower fixing rings are made of NBR or FPM (FKM), which provides higher resistance to heat and chemicals.

7 Oil Lifter

Provides lubrication and cooling of the seal faces down to 1/3 of normal oil level, thus maintaining a stable shaft sealing effect and prolonging seal life longer. The Oil Lifter is Tsurumi original design.

8 Seal Pressure Relief Ports (7.5kW and above)

Protect the mechanical seal from pump pressure. They also protect the seal face by discharging wear particles.

9 Oil Seal (5.5kW and below)

Used as a "Dust Seal", it protects the mechanical seal from abrasive particles.

10 Labyrinth Ring (7.5kW and above)

Equipped to provide a better countermeasure against wear caused by high pressure generated in the casing and improve the maintainability.

11 High-chromium Cast Iron Semi-open Impeller

Resists wear caused by abrasive particles and enables the pump to maintain its original performance for an extended period of time.

12 Agitating Mechanism (KTD)

Consists of a shaft-mounted agitator and a dedicated strainer. The agitator made of high-chromium cast iron resists wear caused by abrasive particles, and it suspends solids to assist in pumping sediments in combination with the strainer.

Automatic Drainage Pumps with Electrode Control Device

Contributing to reduction of power consumption, prevention of dry-running and extension of operating life.



Automatic Operation

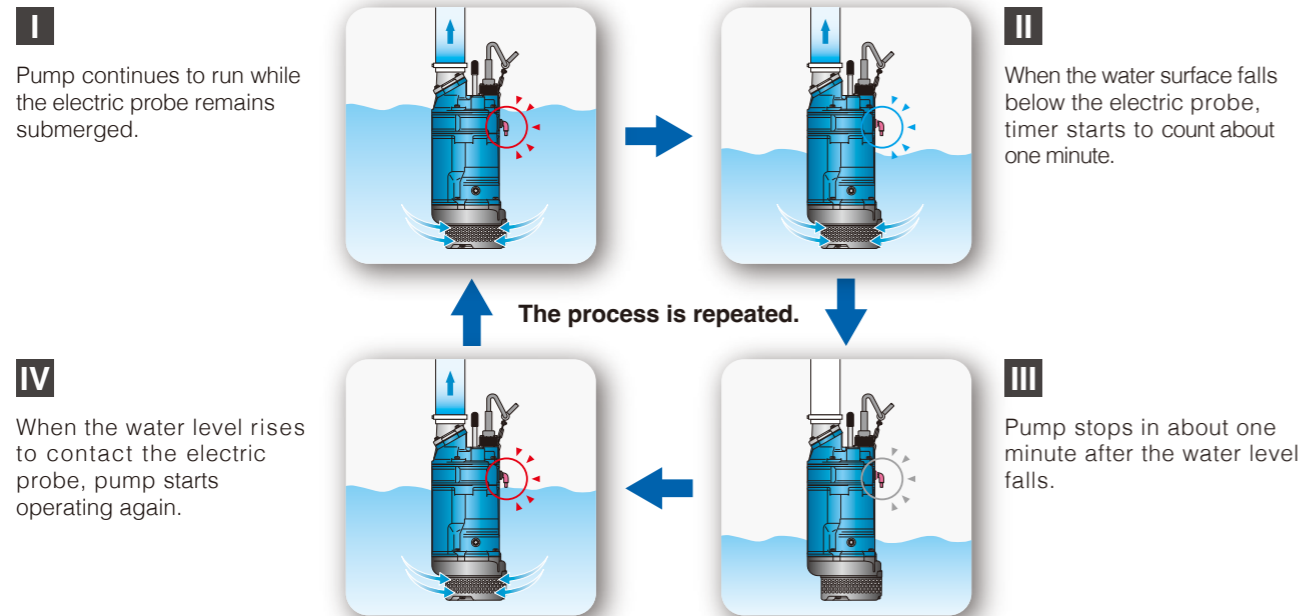

40 % Reduction in Power Consumption

Electrode Control Device

Tsurumi has developed a unique automatic control device utilizing an electrode. It consists of an electric probe and relay unit. When the water level rises to contact the electric probe, electric continuity is produced between the electrode and the pump body, and the relay unit built into the pump turns on the pump.

The relay unit includes a timer function. The pump stops automatically in about one minute after the water surface falls below the electric probe. If the water level rises again to contact the electric probe within the run time, the pump continues to run for one more minute.

Since this mechanism eliminates dry-running, the pump can reduce power consumption by up to 40 percent compared with non-automatic pumps (Tsurumi comparison). It also prevents chattering caused by a turbulent water surface and extends operating life.

It is possible to set a lower starting water level by using an extension probe (optional accessory). The starting water level is adjustable because the extension probe can be cut to the desired length as it is made of coil spring.

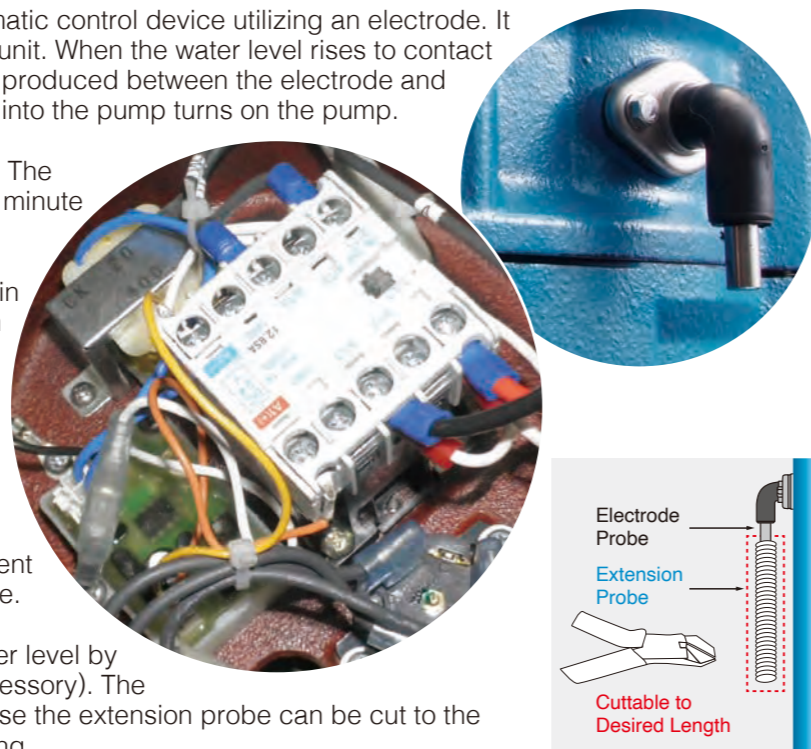

Example of use of automatic pumps in an underground car park

Simply connect the pumps to a power supply for automatic operation.

By setting up multiple Tsurumi automatic pumps at different height levels, these pumps prevent damage caused by submersion in flood water resulting from heavy rain. These pumps do not require any complex setting or installation work. Installation is as easy as positioning the pumps and connecting them to a power supply. If flooding occurs and the water level increases, the pumps automatically start pumping out water.

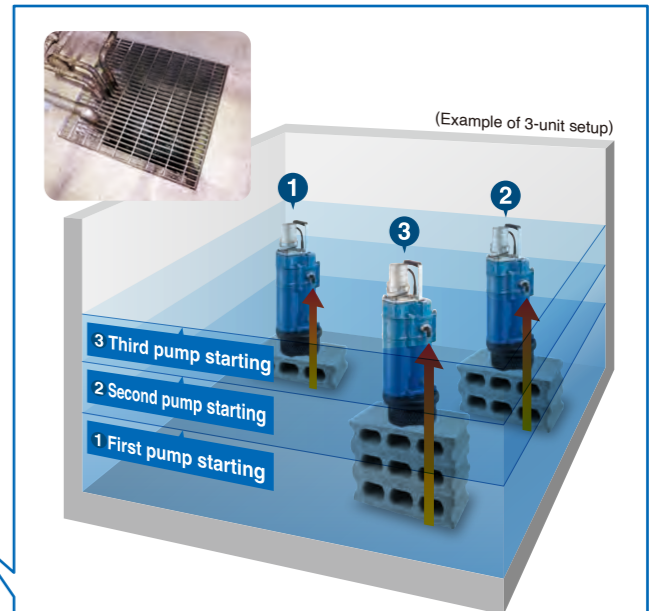

Adjusting the start water level by setting up multiple automatic pumps

The pumps automatically start pumping out water when the water level rises, and also automatically stop when the water level decreases. Simply raise or lower the pump position using blocks or bricks to set the water level at which the pump starts operation.

For an underground car park where flood water may enter, Tsurumi automatic pumps can effectively prevent damage caused by submersion.

Electrode Probe Cover

The electrode probe for the water level sensor is a critical component for the automatic operation of the pump. Pumps are occasionally subjected to strong impacts during installation or when moving from place to place in harsh sites such as construction and mining.

Therefore, Tsurumi has prepared a probe cover made of structural steel to protect the electrode probe from strong impacts. This component can be easily installed in the field.



KTZ –Flagship Line–

The KTZ-series is a submersible three-phase cast iron high head heavy-duty drainage pump. The cast iron body with high-chromium cast iron impeller enables it to withstand demanding conditions found in construction, aggregate and mining applications. The top discharge, side flow design assures efficient motor cooling even when it operates with its motor exposed to air. The slim design allows the pump to be placed in a confined space. The discharge direction is selectable between vertical and inclined, which prevents folding or bending of the discharge hose. The pump with 7.5 to 22kW motor incorporates seal pressure relief ports that prevent the pumping pressure from applying to the shaft seal.



Discharge Bore mm	Model	Motor Output kW	Phase	Starting Method	Solids Passage mm	Dry Weight* ² 50 / 60Hz kg	Cable Length m
50	KTZ21.5	1.5	Three	D.O.L.	8.5	34	8
50	KTZ22.2	2.2		D.O.L.	8.5	35	8
50	KTZ23.7	3.7		D.O.L.* ¹	8.5	60	8
80	KTZ31.5	1.5		D.O.L.	8.5	33	8
80	KTZ32.2	2.2		D.O.L.	8.5	34	8
80	KTZ33.7	3.7		D.O.L.* ¹	8.5	60	8
80	KTZ35.5	5.5		D.O.L.* ¹	8.5	74	8
100	KTZ43.7	3.7		D.O.L.* ¹	8.5	60	8
100	KTZ45.5	5.5		D.O.L.* ¹	8.5	74	8
100	KTZ47.5	7.5		D.O.L.* ¹	12	101	8
100	KTZ411	11		D.O.L.* ¹	12	133	8
100	KTZ415	15		D.O.L.	12	146	8
100	KTZ422	22		D.O.L.	8.5	295 / 294	10
150	KTZ67.5	7.5		D.O.L.* ¹	20	100	8
150	KTZ611	11		D.O.L.* ¹	20	133	8
150	KTZ615	15		D.O.L.	20	147	8
150	KTZ622	22		D.O.L.	12	296 / 295	10

*¹ Star-Delta available upon request

*² Weights excluding cable

Performance Curves

< 50-80mm >

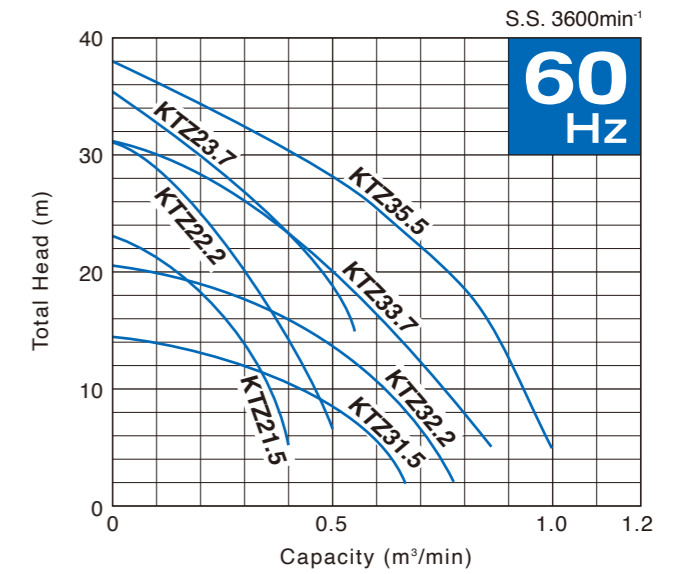
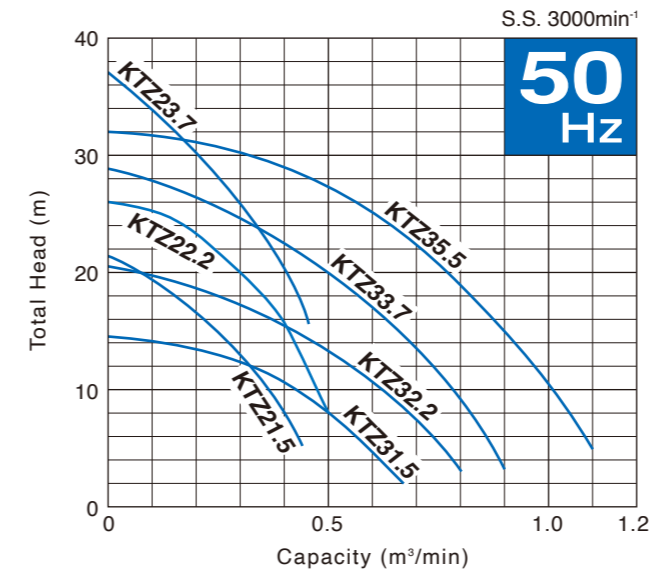

< 100-150mm >

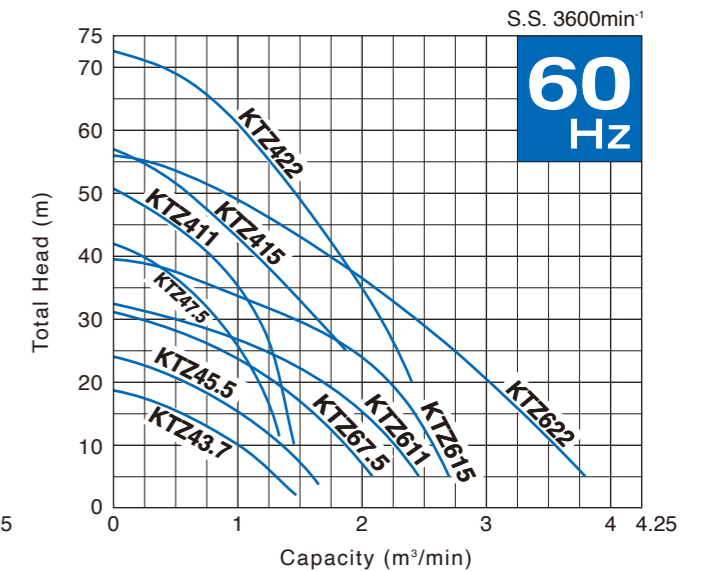
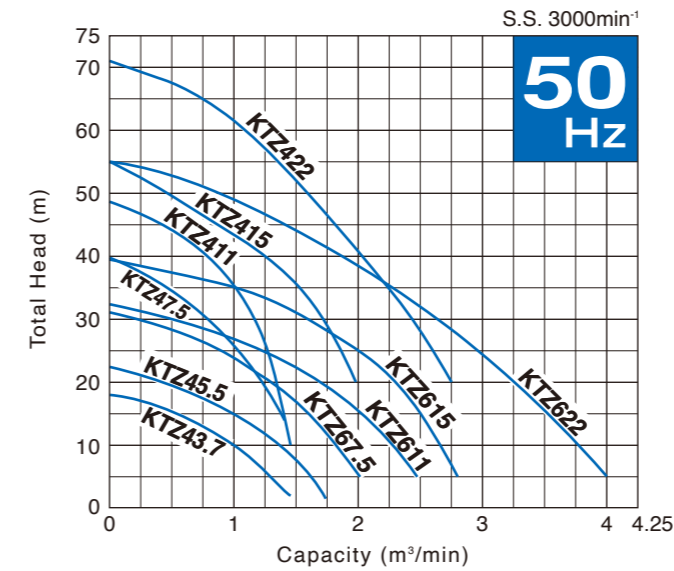

Dimensions

Unit: mm

Model	d	A	A1	B	D	H	W1
KTZ21.5	50	270	235	543	216	548	120
KTZ22.2	50	270	235	563	216	568	120
KTZ23.7	50	342	283	675	252	637	150
KTZ31.5	80	276	235	543	216	548	120
KTZ32.2	80	276	235	563	216	568	120
KTZ33.7	80	347	283	675	252	637	150
KTZ35.5	80	358	306	719	258	688	150
KTZ43.7	100	367	283	690	252	637	150
KTZ45.5	100	377	306	734	258	688	150
KTZ47.5	100	399	330	812	314	697	190
KTZ411	100	428	374	864	350	740	190
KTZ415	100	428	374	934	350	810	190
KTZ422	100	528	485	1200	413	1123	330
KTZ67.5	150	445	361	875	314	697	190
KTZ611	150	457	374	884	350	740	190
KTZ615	150	457	374	954	350	810	190
KTZ622	150	558	485	1220	413	1123	330

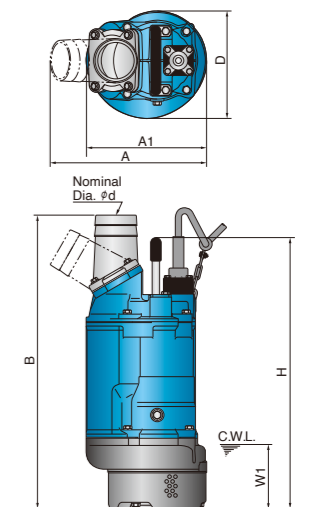

KTZE – Automatic Operation with Electrode–

The KTZE-series is a submersible three-phase automatic cast iron high head heavy-duty drainage pump. An innovative electrode type relay unit built into the pump automatically starts and stops the pump to eliminate dry-running. This mechanism greatly reduces power consumption and extends operating life. The cast iron body with high-chromium cast iron impeller enables it to withstand demanding conditions found in construction, aggregate and mining applications. The top discharge, side flow design assures efficient motor cooling even when it operates with its motor exposed to air. The slim design allows the pump to be placed in a confined space. The discharge direction is selectable between vertical and inclined, which prevents folding or bending of the discharge hose.

- ▶ No control panel required
- ▶ Dry-running prevention
- ▶ Pump life longer



Performance Curves

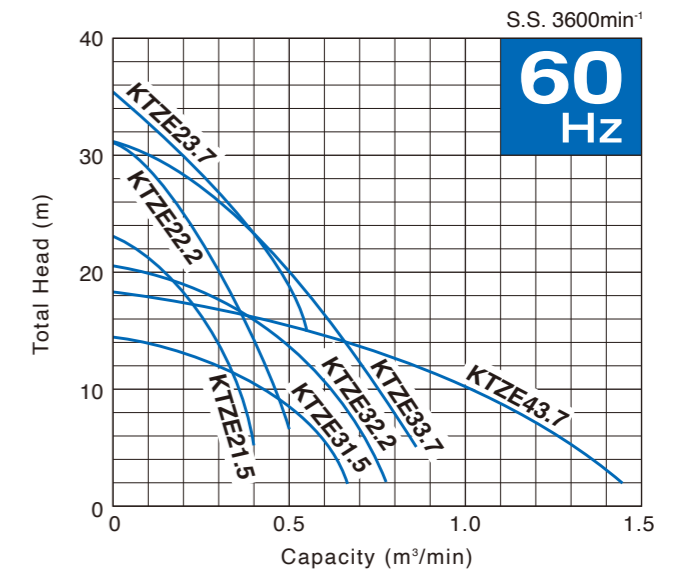
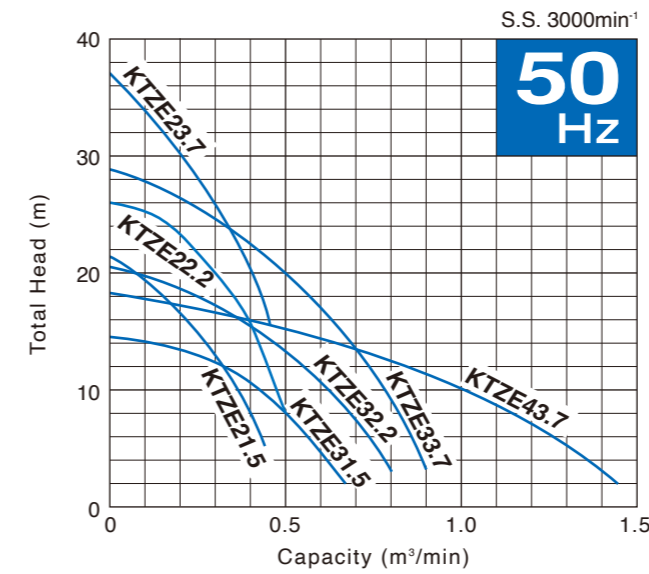

Dimensions

Unit: mm

Model	d	A	A1	B	D	H	W1
KTZE21.5	50	270	235	623	224	628	345
KTZE22.2	50	270	235	643	224	648	355
KTZE23.7	50	342	283	755	252	717	435
KTZE31.5	80	276	235	623	224	628	345
KTZE32.2	80	276	235	643	224	648	355
KTZE33.7	80	347	283	755	252	717	435
KTZE43.7	100	367	283	770	252	717	435

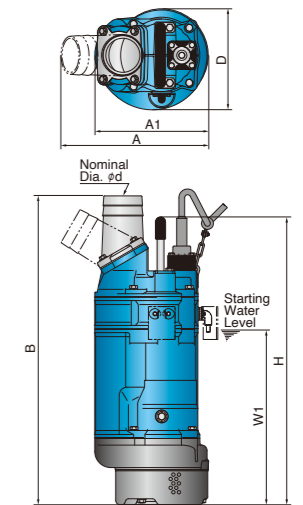

Discharge Bore mm	Model	Motor Output kW	Phase	Starting Method	Solids Passage mm	Dry Weight* kg	Cable Length m
50	KTZE21.5	1.5	Three	D.O.L.	8.5	39	8
50	KTZE22.2	2.2		D.O.L.	8.5	41	8
50	KTZE23.7	3.7		D.O.L.	8.5	69	8
80	KTZE31.5	1.5		D.O.L.	8.5	38	8
80	KTZE32.2	2.2		D.O.L.	8.5	40	8
80	KTZE33.7	3.7		D.O.L.	8.5	69	8
100	KTZE43.7	3.7		D.O.L.	8.5	69	8

* Weights excluding cable



KTD –Slurry Pumps with Agitator–

The KTD-series is a submersible three-phase cast iron heavy-duty slurry pump. It is equipped with an agitator that assists smooth suction of the settled matters. The pump parts such as the impeller and the suction cover are made of wear-resistant materials. The top discharge, side flow design assures efficient motor cooling even when it operates with its motor exposed to air. The slim design allows the pump to be placed in a confined space.



Discharge Bore mm	Model	Motor Output kW	Phase	Starting Method	Solids Passage mm	Dry Weight* kg	Cable Length m
50	KTD22.2	2.2	Three	D.O.L.	10	38	8
80	KTD33.7	3.7		D.O.L.	10	65	8

* Weights excluding cable

Performance Curves

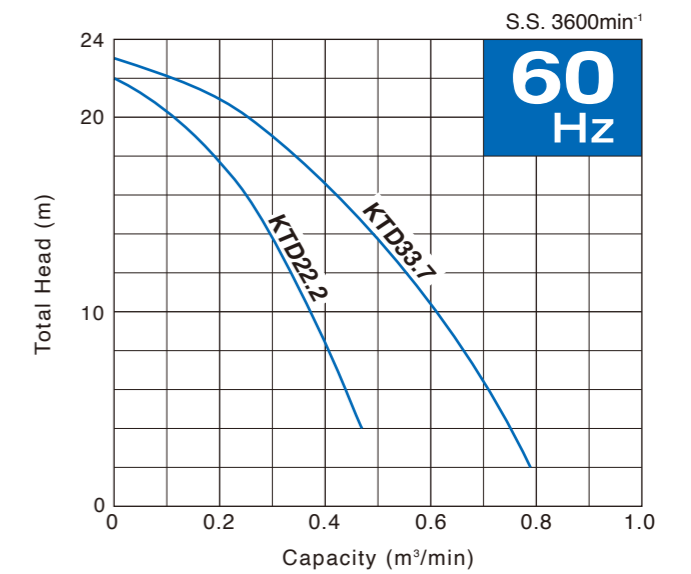
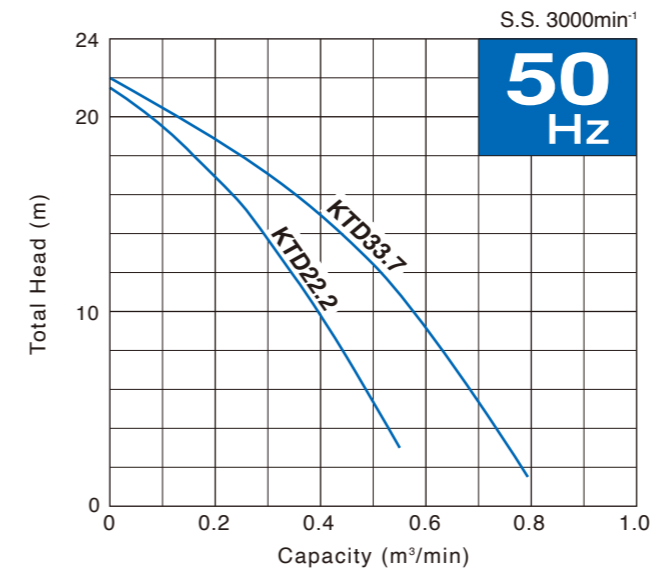

Dimensions

Unit: mm

Model	d	A	B	D	H	W1
KTD22.2	50	235	550	221	519	140
KTD33.7	80	297	644	266	654	160

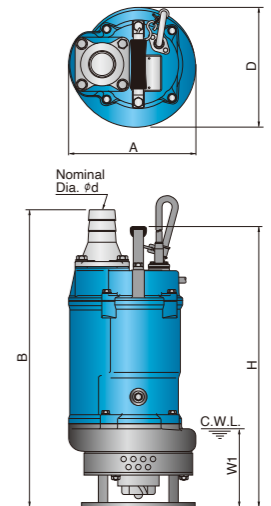

Agitator

Tsurumi's slurry pumps have an agitator made of abrasion resistant material. It is mounted on the shaft and rotates to create a downward current. This agitator assists the pump in sucking and transferring bentonite slurry, slime, mud, and water with high sand content.

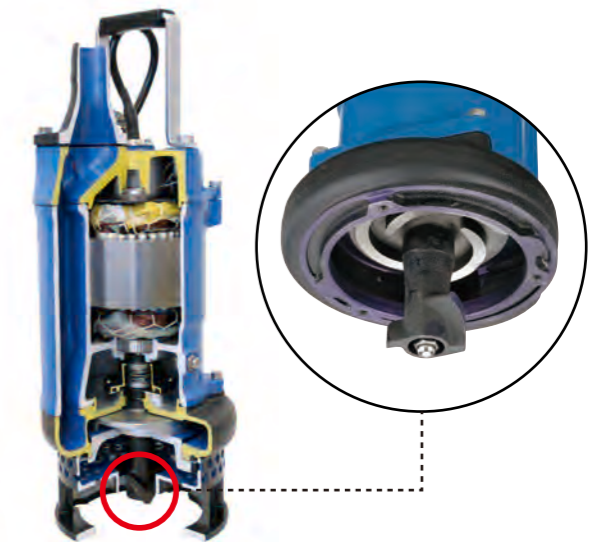

Specifications

		KTZ											KTZ				KTZE -Automatic-						KTD -Slurry-					
		KTZ21.5 KTZ22.2	KTZ23.7	KTZ31.5 KTZ32.2	KTZ33.7	KTZ35.5	KTZ43.7	KTZ45.5	KTZ47.5	KTZ411	KTZ415	KTZ422			KTZ67.5	KTZ611	KTZ615	KTZ622	KTZE21.5	KTZE22.2	KTZE23.7	KTZE31.5	KTZE32.2	KTZE33.7	KTZE43.7	KTD22.2	KTD33.7	
PUMP	Discharge Bore mm	50		80			100								150			50			80			100	50	80		
	Discharge Connection	Hose Coupling													Hose Coupling													
	Solids Passage mm	8.5						12		8.5					20		12		8.5						10			
	Impeller	Semi-open													Semi-open													
		High-chromium Cast Iron													High-chromium Cast Iron													
	Suction Cover	Ductile Cast Iron													Ductile Cast Iron													
	Oil Seal	Nitrile Butadiene Rubber						—							—			Nitrile Butadiene Rubber										
	Labyrinth Ring	—						304 Stainless Steel							304 Stainless Steel			—										
	Casing	Gray Cast Iron													Gray Cast Iron													
	Shaft Seal	Dual Inside Mechanical Seals (with Oil Lifter)													Dual Inside Mechanical Seals (with Oil Lifter)													
Silicon Carbide													Silicon Carbide															
Agitator	—													—											Ductile Cast Iron			
MOTOR	Type	Continuous-duty Rated, Dry-type Induction Motor													Continuous-duty Rated, Dry-type Induction Motor													
	Output kW	1.5 2.2	3.7	1.5 2.2	3.7	5.5	3.7	5.5	7.5	11	15	22			7.5	11	15	22	1.5	2.2	3.7	1.5	2.2	3.7	2.2	3.7		
	Phase	Three													Three													
	Pole	2													2													
	Insulation	F													F													
	Starting Method	D.O.L.	D.O.L.*2	D.O.L.	D.O.L.*2					D.O.L.				D.O.L.*2		D.O.L.		D.O.L.										
	Motor Protector (built-in)	CTP									MTP				CTP			MTP		CTP								
	Lubricant ml	740	1250	740	1250	1100	1250	1100	760	820	2000			760	820	2000	740	1250	740	1250	740	1250	740	1250				
		Turbine Oil (ISO VG32)													Turbine Oil (ISO VG32)													
	Frame	Gray Cast Iron													Gray Cast Iron													
Shaft	420 Stainless Steel													420 Stainless Steel														
Power Cable m	8									10				8		10		8										
	PVC	Chloroprene Rubber	PVC	Chloroprene Rubber									Chloroprene Rubber			PVC	Chloroprene Rubber	PVC	Chloroprene Rubber	PVC	Chloroprene Rubber	PVC	Chloroprene Rubber					
Automatic Control Device	—													—											Electrode		—	
Dry Weight*1 50/60Hz kg	34 35	60	33 34	60	74	60	74	101	133	146	295/294			100	133	147	296/295	39	41	69	38	40	69	38	65			

*1 Weights excluding cable *2 Star-Delta available upon request



We reserve the right to change the specifications and designs without prior notice. The OO series and model OO are indicated with our series/model codes in this catalog.

**TSURUMI
MANUFACTURING CO., LTD.**

www.tsurumi-global.com



Web



Social Media

Your Dealer